

Please read carefully: Read through these instructions completely before commencing installation. Retain for future use.

4 INSTALLATION

The infrared lamp heat by direct radiation rather than by heating the air in the room, so the bathroom heater should be located directly over the drying area. Bathroom heater must not be installed where there is a possibility of water splashing on to the lamps. Locate in accordance with the requirements of the Australian/New Zealand Wiring Rules AS/NZS 3000 relating to damp situations. This means that no part may be located directly above any part of the bath or shower recess or enclosure. For unenclosed showers refer to Wiring Rules conditions.

Note: Steam will only be removed if there is sufficient flow of air through the room. Ensure adequate inlets exist through windows, vents or under the door. Airflow path from inlets to fan should ideally pass over the steam sources.

5 LOCATION

The bathroom heater is for ceiling mounting only, with the lowest point to be at least 2.2 metres above floor level. It is not intended to be installed in wardrobes or within 300 mm of sides of walls, as per Fig. 2. There is a danger of combustion if placed too close to curtains or other flammable materials.

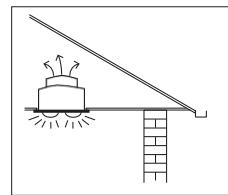

Fig: 1

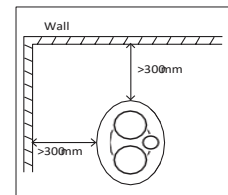

Fig: 2

6 CEILING PREPARATION AND INSTALLATION

Bathroom heater may be installed either between joists using the built in clip fasteners or against a joist using a screw to replace a clip. Drill a hole in the flange to suit. The clearances between bathroom heater and adjacent building members shown in Fig. 3 shall be observed. Thermal insulation or similar material shall not be placed on top of the unit, and adjacent material to the side shall be kept clear to a minimum distance of 200 mm (Fig. 4). Joists, beams and rafters shall not be cut or notched to install bathroom heater. After determining the location of bathroom heater use cut-out template provided to mark out and cut the aperture (Fig. 5). If adequate support is not available for the bathroom heater, it may be necessary to provide extra strengthening.

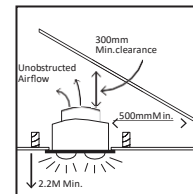

Fig: 3

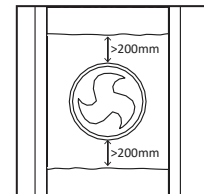

Fig: 4

7 FIXING TO CEILING

Remove all lamps to prevent damage from clip fasteners. Spin the fan to check for freedom of rotation. Push the bathroom heater body into the opening allowing the springs to snap open. To secure, push the lower ends of the springs apart (Fig. 6). Ceiling board thickness should be adjusted to enable the springs to be fitted without excessive force.

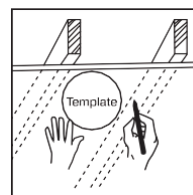

Fig: 5

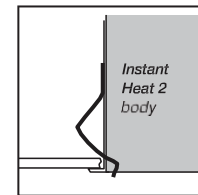

Fig: 6

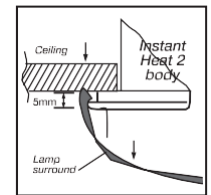

Fig: 7

8 FINAL ASSEMBLY

Check that the power to the unit is off. Position the lamp surround below the unit so that the two pins on the underside line up with the two holes in the flange. The cover is designed to snap onto the housing flange (Fig. 7) which sits flush against the ceiling. Insert the three lamps into the sockets, tightening well to ensure good electrical contact and long life. Wipe the surround and the bulbs clean. Connect the power and check all functions.

1 SPECIFICATIONS

Cat. No.	BH2NDWE/BH2NDMS
Supply Voltage	230-240 V a.c. 50 Hz
Power Input	600 W
Fan Motor	40 W
Airflow	240 m ³ /hr max*
Ceiling cut-out	Ø 300 mm
Protrusion into ceiling	237 mm
Required Ceiling Depth	530 mm
Face protrusion (Excluding Lamps)	20 mm
Heat Lamps	2 x 275 W
LED Centre Light	7 W R80 600 lm
Impeller Diameter	Ø 240 mm
Sound pressure level (dBA) at 3m	44
Weight (Normal)	3.3 kg

* Airflow dependent on installation conditions.

2 PART SUPPLIED

Bathroom heater	1 piece
Infrared heat lamp (L275HLES)	2 piece
LED centre lamp (LR80014K)	1 piece
Wall switch plate (ED770 / 3FLHWE)	1 piece
Installation instructions / template	1 piece

3 THINGS TO BE CONSIDERED

Read through these instructions completely before commencing installation.

CAUTION:

This product is not designed to be ducted. If ducting is required then the ducted Instant Heat series, R622D2 is more suitable for this purpose.

Regulations concerning the discharge of air have to be fulfilled. Local building codes may require venting to the outside. The volume of the roof space must be a minimum of 3 cubic metres and adequately ventilated to allow moisture to dissipate. This product is to be installed in standard roof applications only, not in restricted ceiling cavities as found in multi storey applications (See Fig. 1).

To prevent heat accumulation, adjacent recessed bathroom heaters must be installed at least 1.5 metres apart from each other.

9 WIRING

Three switches on an Excel Life™ wall plate are supplied. Do not use with any solid state speed control. Wall plate should be located so that the switches are not within reach of a person in a bath or shower. Wiring connection is as per Fig. 8.

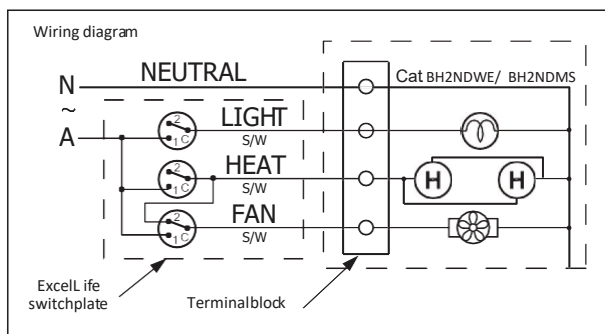

Fig: 8

Note: The fan will run automatically when the heat lamp is switched ON.

CAUTION: Warranty will be void if the bathroom heater unit is not wired as per wiring diagram (Fig.8) above.

10 MAINTENANCE

Cleaning:

1. Isolate the bathroom heater from the 240 V supply. Ensure the lamps are cool to touch before handling.
2. Wipe lamps and fascia with care using a soft cloth soaked with a neutral detergent.

Lamp Replacement:

1. Isolate the bathroom heater from the 240 V supply. Ensure the lamps are cool to touch before handling.
2. Replace LED light globe with HPM Cat. No. LR80014K or E27 R80 100 W max. equivalent.
3. Replace heat lamp with HPM Cat. No: L275HLES or E27 275 W max equivalent (Not suitable for use with 375 W heat lamps).

PRODUCT NOTES

1. For indoor use only.
2. Use the bathroom heater only as described in this instruction. Other use not recommended by Legrand may cause fire or electric shock.
3. This appliance is not intended for use by persons (including children) with reduced physical, sensory or mental capabilities, or lack of experience and knowledge, unless they have been given supervision or instruction concerning use of the appliance by a person responsible for their safety. Children should be supervised to ensure that they do not play with the appliance.
4. This heater is not equipped with a device to control the room temperature. Do not use this heater in small rooms when they are occupied by persons not capable of leaving the room on their own, unless constant supervision is provided.
5. This appliance is intended for household use and similar purposes. It is not suitable for use in an environment heavily laden with dust. Under these conditions the life of the fan motor can be significantly reduced.
6. Exhaust fans may adversely affect the safe operation of appliances burning gas or other fuels (including those from other rooms) due to back flow of combustion gases. These gases can potentially result in carbon monoxide poisoning. After installation of an exhaust fan such as a partition fan, the operation of flued gas appliance should be tested by a competent person to ensure that back flow of combustion gases does not occur.
7. All wiring must be carried out by a licensed electrician in accordance with applicable national/ local codes and standards.
8. The lamps are hot when in use. Do not touch the infrared lamps with any part of your body when in use. Allow all lamps to cool sufficiently before touching or replacing.
9. This product contains no serviceable parts, and no attempt should be made to repair this product. If the product is faulty it should be discarded.
10. This product must be cleaned periodically from dust and other contaminants with a damp cloth. Cleaning agents and solvents should never be used.
11. Airflows listed in this product indicate the product performance. Refer to the BCA (Building Code of Australia), or similar, for the appropriate number of room air changes required for a particular installation.
12. This product has been designed to operate in ambient temperatures between 5°C to 40°C.
13. Ventilation products must have an adequate source of external air to ensure rated performance can be achieved.
14. This product should not be enclosed in thermal insulation as it may cause the unit to overheat.
15. The terminals on this product should be tightened between 0.4Nm and 0.6Nm. Over tightening may damage the product. Under tightening may result in hot joints.
16. This product is not suitable for installation in hazardous and/or corrosive areas.
17. This product has been designed for domestic or similar uses and is not suitable for a commercial installation.
18. The material in this product may vary in colour from batch to batch. Colour matching from one batch to another cannot be guaranteed.
19. This product has been designed to operate on a nominal supply voltage of 230-240 V a.c. 50 Hz.
20. The lamps on this product should be tightened until fit is secure. Over tightening may damage the lamp and under tightening may result in hot joints.
21. After installation this product must be tested as required by the appropriate government and/or statutory regulations.
22. This product utilises intellectual property in the form of registered designs, trademarks, and/or patents. Such intellectual property remains the property of Legrand in all cases.
23. Legrand reserves the right to modify the specification of this product at anytime.

Warranty



- Legrand ("we or us") has given each purchaser who is a consumer ("you") a warranty against defects in its products.
- As a consumer, you are entitled to the benefit of the Warranty and should read and understand its terms. In addition, for the purposes of the Australian and New Zealand Consumer Laws, we note the following:
 - If we accept your claim under the Warranty we will reimburse all your reasonable expenses in making and pursuing the claim, including the cost of reimbursement of any defective products returned in the ordinary course to us at the address above by post or other agreed means. Any such claim must be made within 14 days of your receiving notice of our acceptance of your claim and include any necessary supporting documentation or invoices.
 - As a consumer, you have rights under the Australian and New Zealand Consumer Laws and may have rights under other applicable laws which cannot be excluded, restricted or modified. Those rights are in addition to any rights you have under the Warranty.
 - Legrand warrants this product for a period of 5 years from the date of purchase. Our goods (which we refer to in the Warranty as the Products) come with guarantees that cannot be excluded under the Australian and New Zealand Consumer Laws. You are entitled to a replacement or a refund for a major failure and compensation for any other reasonably foreseeable loss or damage. You are also entitled to have the goods repaired or replaced if the goods fail to be of acceptable quality and the failure does not amount to a major failure.

- Our contact details for the purpose of any claims made under the Warranty are below. Any claim under the Warranty must be sent in writing to the following address:

AUSTRALIA ONLY
 Legrand Australia Pty Ltd
 Nexus Industry Park
 Bldg 4, 43-47 Lyn Parade
 PRESTONS, NSW 2170
 1300 369 777
 sales.orders@legrand.com.au

NEW ZEALAND ONLY
 Legrand New Zealand Ltd
 106-124 Target Rd
 GLENFIELD, AUCKLAND
 0800 476 009
 nz.sales@legrand.co.nz

